

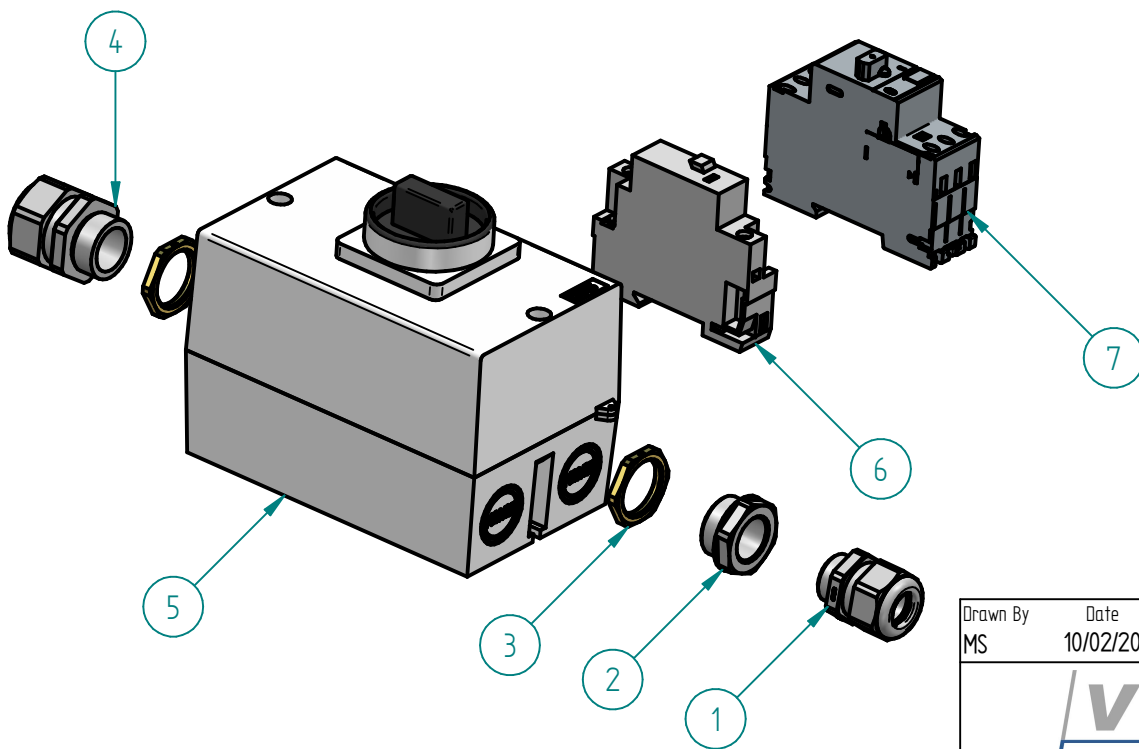

TOLERANCES acc. to ISO / TOLERANSEER enl. ISO
 Applicable where no tolerance is indicated.
 Gælder der tolerans er ej direkte udsatts
 For machining / For bearbejning: ISO 2768-mK
 For welding / For svetsning: SS-EN ISO 13920-BF
 Surface finish acc. to: ISO 1302 Machined surfaces.
 Ytjæmnhed enlgt: ISO 1302. For bearbejtede ytor.

Item	Artikelnummer	Document Number	Title	Quantity
1	114813		SCREWED CABLE GLAND M20 PLAST	1
2	115099		REDUCTION M25/M20	1
3	115297	791.80.82	COUNTER NUT BRASS, M25	2
4	114814	791.80.52	SCREWED CABLE GLAND M25 PLAST	1
5	115459		SWITCH HOUSING	1
6	900055		UNDervOLTAGE TRIP	1
7	900056		POWER SWITCH	1
8	109007		CABLE LUG $\phi=5$	2
9	109009		ELECTRIC WIRE TERMINAL	4
10	114881		EL. CABLE 5 X 2.5 PURWIL	1,2
11	114882		EL. CABLE 3 X 2.5 PURWIL	1
12	900015		EL. CABLE 1 X 1.5mm ² , RED	0,2
13	900019		EL. CABLE 1 X 1.5mm ² , WHITE	0,1
14	900020		UNINSULATED WIRE TERMINAL 2,5mm ²	14
15	900000		CABLE TIE 280X3,5, NATURAL	1



Material	Dimension
	Units : mm
	SIZE A4

Drawn By MS	Date 10/02/2020	Approved Date 10.02.2020	Approved By MS		
			Description ELECTRIC SWITCH PRE-ASS.		Article Number 800003
					DWG NO 625.38.02
Part/Assembly File 6253802.asm			sheet 1	of 2	
				Rev.	

TOLERANCES acc. to ISO / TOLERANSEER enl. ISO
 Applicable where no tolerance is indicated.
 Gäller där tolerans ej direkt utsatts
 For machining / För bearbetning: ISO 2768-mK
 For welding / För svetsning: SS-EN ISO 13920-BF
 Surface finish acc. to: ISO 1302. Machined surfaces.
 Ytjämnhet enligt: ISO 1302. För bearbetade ytor.

900061 (900060)
 ELECTRIC MOTOR
 1PH, 115V, 50Hz (60Hz)

Мотор (U1)
 Мотор (U2)
 Мотор (TK1)
 Мотор (TK2)
 Мотор (Pe)

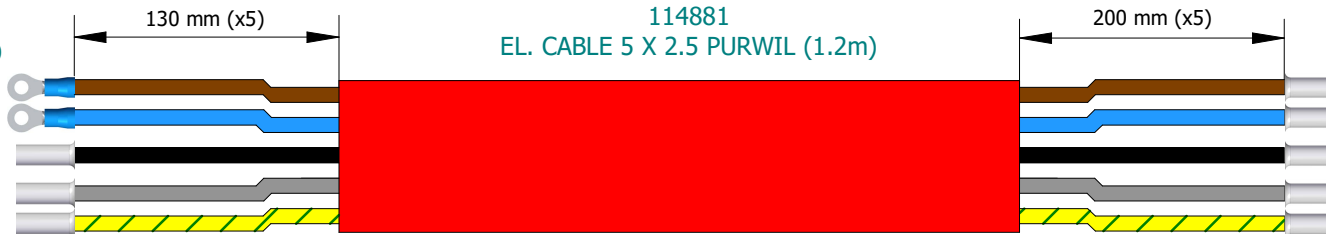

900055
 UNDERVOLTAGE
 TRIP
 900056
 POWER SWITCH

(T2) Ключ
 (T3) Ключ
 (D2) Предпазител
 (L1) Ключ
 (Pe) Кутия на ключа

115459
 SWITCH HOUSING

Захранване (L)
 Захранване (N)
 Захранване (Pe)



900056
 POWER SWITCH

(L1) Ключ
 (L3) Ключ
 (Pe) Кутия на ключа

115459
 SWITCH HOUSING

900056
 POWER SWITCH

Ключ (L2)

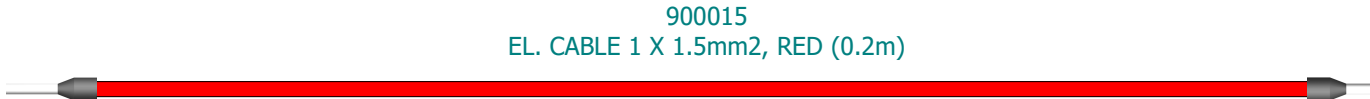

900056
 POWER SWITCH

(T1) Ключ

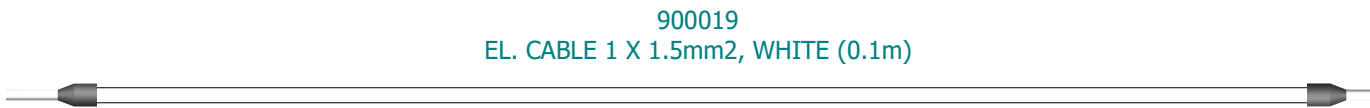

Ключ (L3)



900055
 UNDERVOLTAGE
 TRIP

(D1) Предпазител

Кабелни накрайници
 (Зачистете всички кабели на 8 mm!)

-  109009 ELECTRIC WIRE TERMINAL (4 бр.)
-  109007 CABLE LUG Ø= 5 MM (2 бр.)
-  900020 UNINSULATED WIRE TERMINAL 2,5mm2 (14 бр.)

Material	Dimension
----------	-----------

Drawn By MS	Date 10/02/2020	Approved Date 10.02.2020	Approved By MS	Units : mm	SIZE A4
			Description ELECTRIC SWITCH PRE-ASS.		Article Number 800003
					DWG NO 625.38.02
Part/Assembly File 6253802.asm			sheet 2	of 2	Rev.